

# **Powr-Flite**

**COMMERCIAL FLOOR CARE EQUIPMENT**

## **Commercial Vacuum Cleaner OWNER'S GUIDE Model PF82HF**

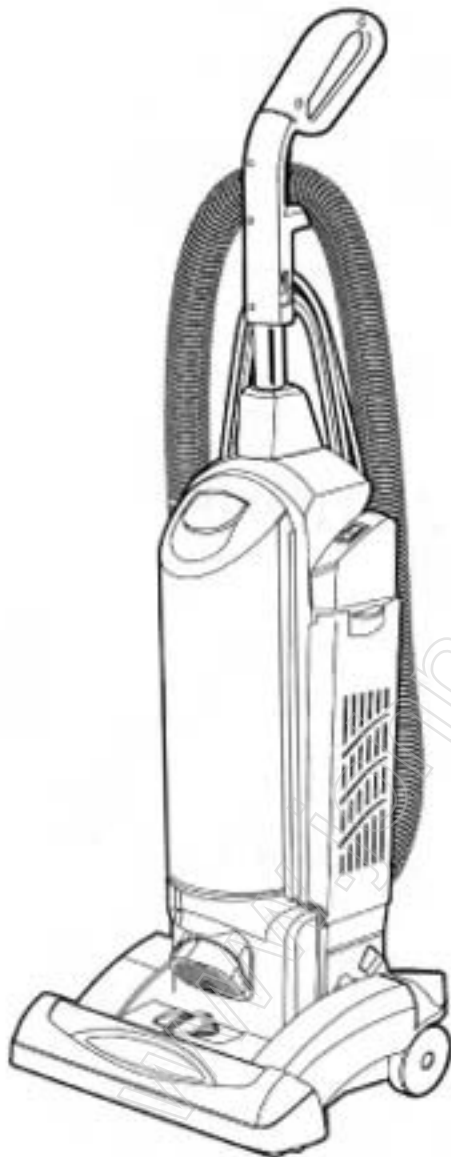

<b>Index</b>	
Important Information .	2-4
Quick Reference .....	5
Use .....	6-7
Accessories .....	7
Dust Bag .....	8
Filter .....	9
Brush Roll.....	10
Brush Roll Belt .....	10
How to Remove Blockages.....	11
Problem Solving .....	12

**For location of nearest Powr-Flite  
Warranty Station or service  
information call 1-800-880-2913**

### **Please Retain**

We suggest you record the model, type and serial numbers below. They are located on the silver rating plate on your cleaner. For prompt and complete service information, always refer to these numbers when inquiring about service.

**Model & Type** \_\_\_\_\_

**Serial No.** \_\_\_\_\_

It is also important to keep your receipt as proof of date of purchase.

# IMPORTANT SAFEGUARDS

When using an electrical appliance, basic precautions should always be followed, including the following:

**READ ALL INSTRUCTIONS BEFORE USING THIS VACUUM CLEANER.**

## WARNING

To reduce the risk of fire, electric shock, or injury:

- Do not use outdoors or on wet surfaces.
- **Do not leave vacuum cleaner when plugged in.** Turn off the switch and unplug the electrical cord when not in use and before servicing.
- This appliance is provided with double insulation. Use only identical replacement parts. See instructions for Servicing of double-insulated appliances.
- Do not allow to be used as a toy. Close attention is necessary when used by or near children.
- Use only as described in this manual. Use only manufacturer's recommended attachments.
- Do not use with damaged cord or plug. If vacuum cleaner is not working as it should, has been dropped, damaged, left outdoors, or dropped into water, return it to a service center before using.
- Do not pull or carry by cord, use cord as a handle, close a door on cord, or pull cord around sharp edges or corners. Do not run vacuum cleaner over cord. Keep cord away from heated surfaces.
- Do not use extension cords or outlets with inadequate current carrying capacity.
- Turn off all controls before unplugging.
- Do not unplug by pulling on cord. To unplug, grasp the plug, not the cord.
- Do not handle plug or vacuum cleaner with wet hands.
- Do not put any object into openings. Do not use with any opening blocked; keep free of dust, lint, hair, and anything that may reduce airflow.
- This vacuum cleaner creates suction and contains a revolving brush roll. Keep hair, loose clothing, fingers, and all parts of body away from openings and moving parts.
- Do not place cleaner on furniture or stairs as the brush roll may cause damage. Place cleaner on floor with the handle in storage position while using attachments.
- Do not pick up anything that is burning or smoking, such as cigarettes, matches, or hot ashes.
- Do not use without dust bag or filter(s) in place.
- Belt pulleys can become hot during normal use. To prevent burns, avoid touching the belt pulley when servicing the drive belt.
- Use extra care when cleaning on stairs.
- Do not use to pick up flammable or combustible liquids such as gasoline, or use in areas where they may be present.
- Store your cleaner indoors in a cool, dry area.
- Keep your work area well lighted.
- Unplug electrical appliances before vacuuming them.

## SAVE THESE INSTRUCTIONS

To reduce the risk of electric shock, this appliance has a polarized plug (one blade is wider than the other). This plug will fit in a polarized outlet only one way. If the plug does not fit fully into the outlet, reverse the plug. If it still does not fit, contact a qualified electrician to install the proper outlet. Do not change the plug in any way.

### GENERAL INFORMATION

Use the cleaner to pick up dirt and dust particles. Avoid picking up hard or sharp objects that could damage the vacuum cleaner.

### Service Information

The instructions in this booklet serve as a guide to routine maintenance. For additional service information, telephone our toll free number for the nearest Powr-Flite Authorized Warranty Station. **You should know the model, type and serial number or date code when you call:**

**USA: 1-800-880-2913**

If you prefer, you can write to Powr-Flite, Service Division, 3101 Wichita Court, Ft. Worth, Texas 76140, USA. Refer to The Powr-Flite Warranty for complete service information



**DO NOT OIL the motor or the brush roll. The motor and brush roll are permanently sealed and lubricated.**

### Thermal Cut Off

This vacuum cleaner has a special thermostat that protects the cleaner in case of motor overheating. If the cleaner suddenly shuts off, push the on/off switch off (0) and unplug the cleaner. Check the cleaner for a possible source of overheating such as a full dust cup, a blocked hose or clogged filter. If these conditions are found, fix them and wait at least 30 minutes before attempting to use the cleaner. After the 30 minute period, plug the cleaner back in and push the on/off switch on (I). If the cleaner still does not run, then take it to a Powr-Flite Authorized Service Center for repair.

# CONSEILS DE SÉCURITÉ

Lors de l'utilisation d'un appareil électrique, quelques précautions élémentaires doivent être observées, incluant les suivantes:

LISEZ TOUTES LES INSTRUCTIONS AVANT D'UTILISER VOTRE ASPIRATEUR.

## AVERTISSEMENT

Pour réduire le risque de feu, de choc électrique, ou de blessure:

- Ne pas utiliser à l'extérieur ou sur des surfaces mouillées.
- Cet appareil est muni d'un double-isolément. Utilisez uniquement des pièces de rechange identiques. Voir les instructions pour l'entretien d'appareils à double-isolément.
- **Fermez le commutateur et débranchez l'appareil lorsque vous ne l'utilisez pas ou avant le nettoyage ou l'entretien.**
- Ne permettez pas qu'il soit utilisé comme jouet. Une attention particulière est nécessaire lorsque utilisé par ou près d'un enfant.
- Suivez les recommandations d'utilisation de ce manuel. Utilisez uniquement les accessoires recommandés par le fabricant.
- Ne pas utiliser si le cordon ou la fiche sont endommagés. Si l'aspirateur ne fonctionne pas comme il le devrait, s'il a été échappé, s'il est endommagé, s'il a été laissé à l'extérieur ou échappé dans l'eau, retournez-le à un centre de service avant d'utiliser.
- Ne pas le tirer ou le transporter par le cordon, ne pas utiliser le cordon en guise de poignée. Ne pas fermer une porte sur le cordon ou tirer le cordon sur des coins ou bordures pointus. Ne pas circuler sur le cordon avec l'aspirateur. Tenir le cordon à distance des surfaces chauffantes.
- Ne pas utiliser des rallonges ou des prises qui n'ont pas de capacité suffisante pour transporter le courant.
- Fermer tous les contrôles avant de débrancher.
- Ne pas débrancher en tirant sur le cordon. Pour débrancher, tenez la fiche et non le cordon.
- Ne pas manipuler la fiche ou l'aspirateur avec les mains mouillées.
- Ne pas rien insérer dans les ouvertures. Ne pas utiliser si des ouvertures sont bloquées; assurez-vous qu'elles soient dégagées de poussière, mousse, cheveux ou toute autre chose qui pourrait réduire le passage de l'air.
- Cet aspirateur crée de la succion et contient un rouleau-brosse tournant. Tenir les parties mobiles et les ouvertures loin des cheveux, du linge, des doigts et de toute partie du corps.
- Ne pas mettre l'aspirateur sur les meubles ou sur les escaliers car le rouleau-brosse peut faire des dommages. Placer l'aspirateur sur le plancher avec le manche en entreposage position temps que les accessoires sont en usage.
- Ne pas ramasser des objets qui brûlent ou fument comme les cigarettes, allumettes ou cendres chaudes.
- N'utilisez pas sans le sac de poussière en place.
- Les poulies du courroie peuvent devenir chaudes pendant l'utilisation normale. Pour prévenir des brûlures, évitez de toucher la poulie du courroie lorsque vous réparez la courroie.
- Portez une attention particulière lorsque vous nettoyez les escaliers.
- Ne pas utiliser pour ramasser des liquides inflammables ou combustibles comme de l'essence: Ne pas utiliser dans les endroits où ces liquides pourraient être présents.
- Entrez votre aspirateur à l'intérieur dans un endroit propre et sec.
- Maintenez un bon éclairage à l'endroit où vous travaillez.
- Débrancher les appareils électrique avant de les balayer.

## CONSERVEZ CES INSTRUCTIONS

**Afin de réduire le risque de choc électrique**, cet appareil est muni d'une fiche polarisée (une des lames est plus large). Cette fiche ne peut être insérée dans une prise polarisée que d'une seule façon. Si la fiche ne peut être insérée dans la prise, retourner la fiche. Si la fiche ne peut toujours pas être insérée dans la prise, faire installer une prise adéquate par un électricien qualifié. Ne pas modifier la fiche.

## SERVICING OF DOUBLE-INSULATED APPLIANCES

A double-insulated appliance is marked with one or more of the following: The words "DOUBLE INSULATION" or "DOUBLE INSULATED" or the double insulation symbol (square within a square).

In a double-insulated appliance, two systems of insulation are provided instead of grounding. No grounding means is provided on a double-insulated appliance, nor should a means for grounding be added to the appliance. Servicing a double-insulated appliance requires extreme care and knowledge of the system, and should be done only by qualified service personnel. Replacement parts for a double-insulated appliance must be identical to the parts they replace.



## THE POWR-FLITE COMMERCIAL LIMITED WARRANTY WHAT THIS WARRANTY COVERS

Your Powr-Flite commercial cleaner is warranted to be free from all defects in material and workmanship in normal use FOR A PERIOD OF ONE YEAR. The warranty is granted only to the original purchaser of the cleaner. The warranty is subject to the following provisions.

### WHAT THIS WARRANTY DOES NOT COVER

- Parts of the cleaner that require replacement under normal use, such as bumpers, bags, bristle strips, belts, light bulbs, hoses, and impellers.
- Damages or malfunctions caused by negligence, abuse, or use not in accordance with Owner's Guide.
- Defects or damages caused by unauthorized service or the use of other than Genuine Eureka parts.

### WHAT THE POWR-FLITE COMPANY WILL DO

The Powr-Flite Company will, at its option, repair or replace a defective cleaner or cleaner part that is covered by this warranty. As a matter of warranty policy, the Powr-Flite Company will not refund the consumer's purchase price.

### WARRANTY REGISTRATION

Please fill out and return the warranty registration card accompanying your cleaner.

### OBTAINING WARRANTY SERVICE

To obtain warranty service you must return the defective cleaner or cleaner part along with proof of purchase to any Powr-Flite Authorized Warranty Station. You will find the nearest location in the Yellow Pages under "Vacuum Cleaners-Service and Repair." Be certain that the Warranty Station is "Powr-Flite Authorized."

For the location of the nearest Powr-Flite Authorized Warranty Station or for service information, telephone toll free:

**USA: 1-800-880-2913**

If you prefer, you can write to:

**Powr-Flite**  
Service Division  
3101 Wichita Court  
Ft. Worth, Texas 76140

If it is necessary to ship the cleaner outside your community to obtain warranty repair, you must pay the shipping charges to the Powr-Flite Authorized Warranty Station. Return shipping charges will be paid by the Warranty Station. When returning parts for repair, please include the model, type, and serial numbers from the data plate on the cleaner.

### FURTHER LIMITATIONS AND EXCLUSIONS

Any warranty that may be implied in connection with your purchase or use of the cleaner, including any warranty of MERCHANTABILITY or any warranty for FITNESS FOR A PARTICULAR PURPOSE is limited to the duration of this warranty. Some states do not allow limitations on how long an implied warranty lasts, so the above limitations may not apply to you.

Your relief for the breach of this warranty is limited to the relief expressly provided above. IN NO EVENT SHALL POWR-FLITE BE LIABLE FOR ANY CONSEQUENTIAL OR INCIDENTAL DAMAGES THAT YOU MAY INCUR IN CONNECTION WITH YOUR PURCHASE OR USE OF THE CLEANER. Some states do not allow the exclusion or limitation of incidental or consequential damages, so the above limitation or exclusion may not apply to you.

This warranty gives you specific legal rights. You may also have other rights which vary by State.



## QUICK REFERENCE

**WARNING:** Avoid injury. Keep loose clothing, hair, fingers, and all other parts of body away from any moving part (such as the revolving brush). Turn off the switch and unplug the cleaner before changing the cleaner height setting.

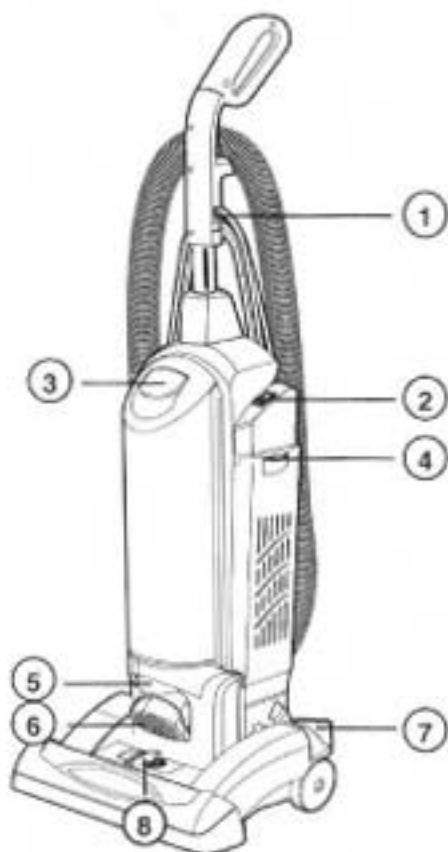

1. **Cord Retainer.** To use, push electrical cord down into cord retainer.
2. **ON/OFF Switch.** International symbol I means On, International symbol O means Off.
3. **Bag Compartment Latch.** Pull up on latch to remove bag compartment door giving access to the dust bag and motor filter.
4. **Filter Door Latch.** Push down on latch and pivot out for access to the filter compartment. Push up on latch to close door.
5. **Stair Handle.** To use when cleaning stairs.
6. **Headlight.**
7. **Handle Release.** Step on handle release to pull handle back to a comfortable operating position.
8. **Cleaner Height Setting.** An adjustment that raises or lowers the cleaner base to match the type of floor surface.

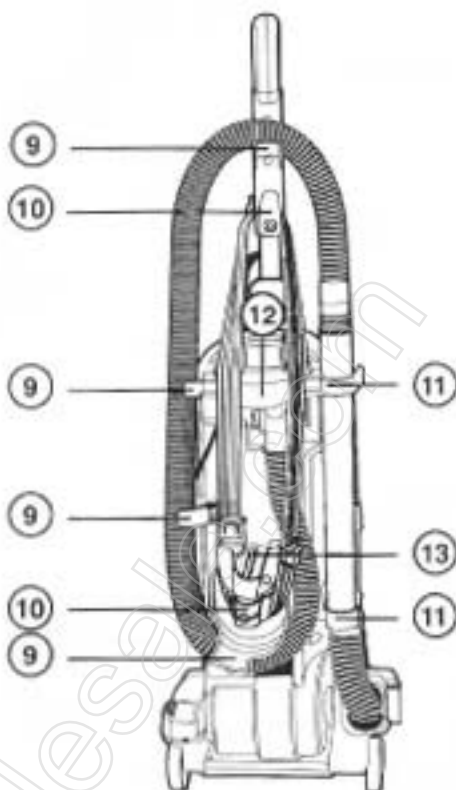

9. **Hose Retainers (4).** Place hose in retainers to store hose on unit.
10. **Electrical Cord Hooks (2).** Wrap electrical cord around them to store electrical cord on unit. The upper cord hook rotates for quick cord release.
11. **Nested Wand Storage.** The crevice wand stores inside the larger wand.
12. **Carrying Handle.** Use this handle to carry unit from one place to another.
13. **Dusting/Upholstery Brush Storage.** Store the dusting brush on back of cleaner.

**NOTE: WHEN UNIT IS RUNNING, DO NOT ATTEMPT TO REMOVE ANY OBJECT WHICH PREVENTS THE BRUSH ROLL FROM TURNING.**

First, turn off unit, unplug from the electrical socket, then remove object from brush roll area. Ex: sock, rug, etc.

### Helpful Information:

**Listen** to your cleaner. If you notice a change in the sound of the motor or a change in performance, it could simply indicate a common usage or maintenance issue. Such as, a need to raise or lower the carpet height adjustment, possible blockage in hose or brush roll area, or a broken or loose brush roll belt. These are all easy to fix and the instructions are included in this owner's guide. Becoming familiar with the information in this guide will help you to get the best possible performance from your new cleaner for many years to come.

## HOW TO ASSEMBLE

**CAUTION:** Assemble the cleaner before using.

**CAUTION:** Moving parts, make sure on/off switch is in off (0) position before plugging in.

**NOTE:** Features may vary by model yet all parts assemble the same.

### Attach Handle

**CAUTION:** Do not catch cord under handle.

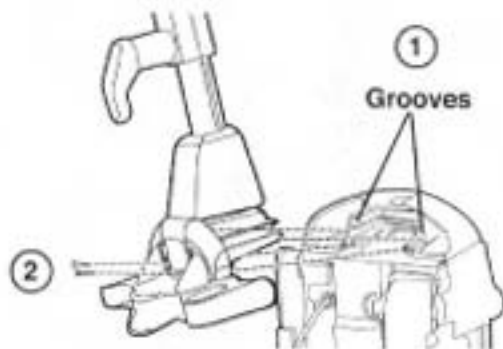

1. From rear of cleaner, align handle with groove and slide onto cleaner. If necessary, use thumb and finger pressure to slide handle into position.
2. Attach handle with the two 1 inch screws provided in the assembly packet. Use a Phillips® head screwdriver.

**NOTE:** Hand tighten with screwdriver to be sure both screws are firmly seated.

### Attach Hose

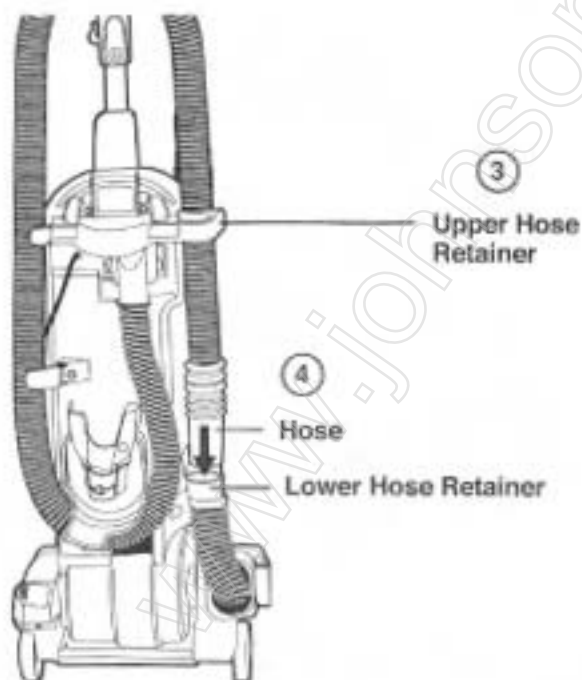

3. Pick up hose and lay across upper hose retainer.
4. Push the end of the hose in the lower hose retainer to secure.

### Store Hose and Accessories

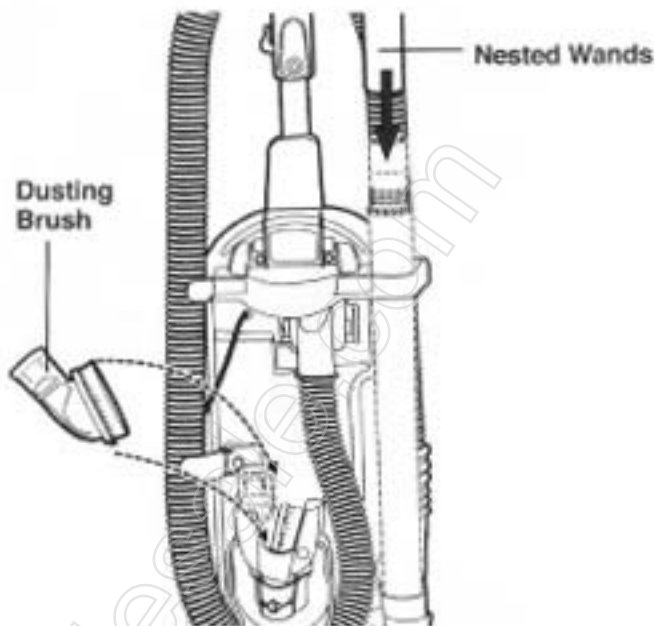

### Store Electrical Cord

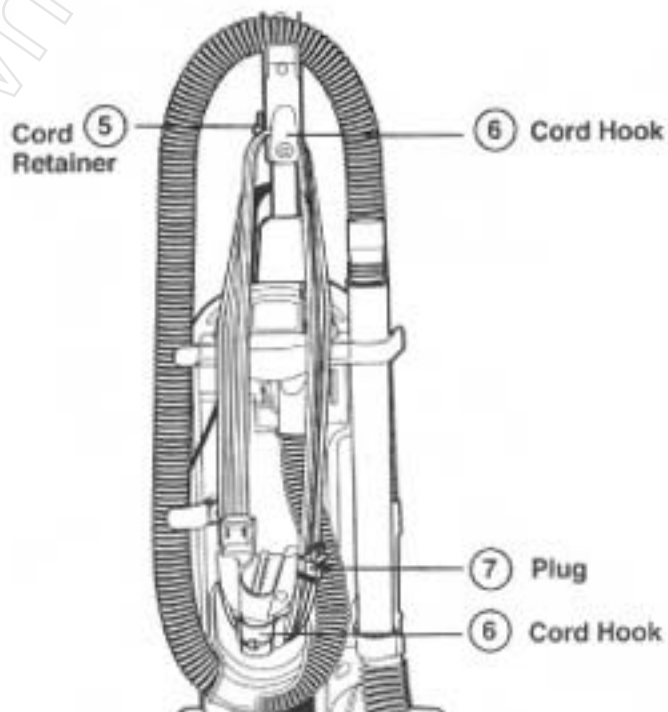

5. You will find your cord retainer on the handle above the upper cord hook. Firmly push the electrical cord down into the cord retainer. This will place the cord out of the way the next time you vacuum.
6. Next wind the cord around the two cord hooks on the back side of cleaner.
7. Secure the plug to the cord to prevent unwinding.

## HOW TO USE



- 1. Handle Release.** Step on handle release to pull handle back to a comfortable operating position. To lower handle completely to the floor, depress handle release a second time.



### Helpful Information:

Before cleaning under low furniture, check area first for objects that might harm the unit or block the vacuum hose.

- 2. Cleaner Height Setting.** An adjustment that raises or lowers the cleaner base to match the type of floor surface. With the cleaner cord unplugged, set the adjustment to lowest setting for maximum carpet cleaning. **If the cleaner is difficult to push, move adjustment to next highest setting until cleaner is comfortable to push.** The brush roll must reach the carpet for effective cleaning. For ease in moving the adjustment knob, place handle in operating position and tilt cleaner back to remove weight from front wheels.

**WARNING: Avoid injury. Keep loose clothing, hair, fingers, and all other parts of body away from any moving part (such as the revolving brush). Turn off the switch and unplug the cleaner before changing the cleaner height setting.**

**NOTE: While using accessories, do not place cleaner on furniture or steps as the brush roll may cause damage. Place cleaner on floor with the handle in storage position.**

- To use accessories remove hose from rear of cleaner by lifting up and twisting.

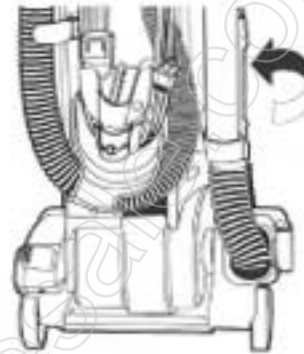

- Place desired accessory onto end of hose or wand.



**Dusting/Upholstery Brush** is for furniture, blinds, books, lamp shades, shelves, curtains, draperies, cushions and fabrics.

**Crevice Wand** cleans corners, stairs, baseboards, and between cushions.

**Nested extension wands** to add reach.

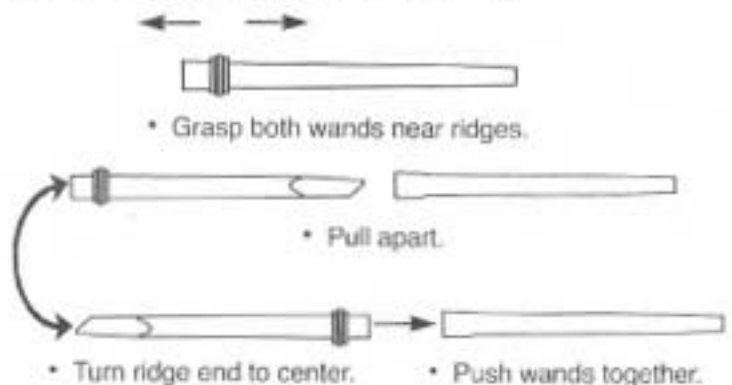

## ROUTINE MAINTENANCE

The instructions in this booklet serve as a guide to routine maintenance. To avoid unnecessary service calls, check the filters, belt, and brush roll often.

**NOTE:** When vacuuming carpet fresheners or cleaners, powder, plaster dust, or similar fine substances, the filters will require more frequent maintenance.

**NOTE:** Turn off the switch and unplug the electrical cord before changing the filter. Never operate the vacuum cleaner without the filter assembly in place.

### Removing the Dust Bag (Style LS):

- 1 Remove dust bag cover by lifting up on latch and pivoting dust bag cover out and away from cleaner.

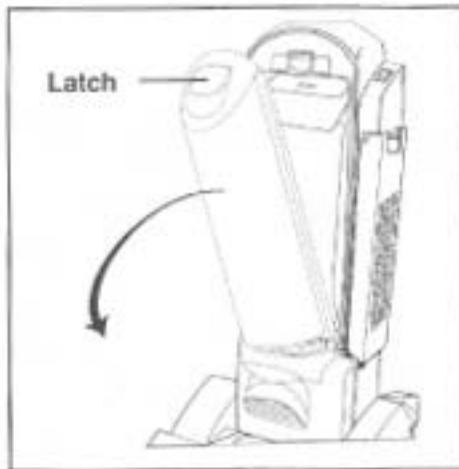

- 2 Grasp dust bag flaps and pull out from cleaner.

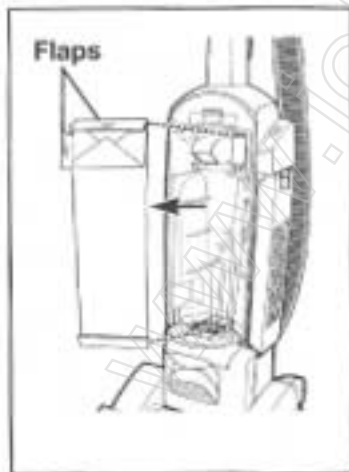

### Installing New Dust Bag:

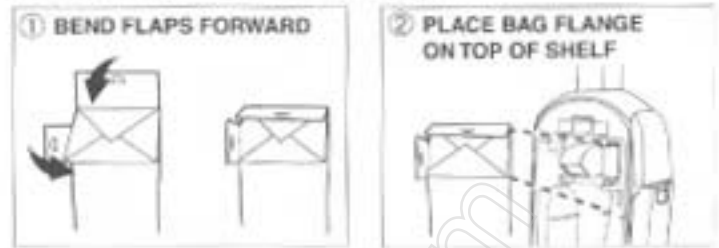

### Reinstalling the Dust Bag Cover:

Place the bottom of the dust bag cover on cleaner lining up grooves on outer edge of cover with rails on side of cleaner. Rotate cover up, pressing against cleaner until it locks into place.





## ROUTINE MAINTENANCE (continued)

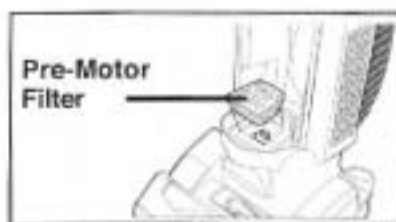

### Pre-Motor Filter

Check the pre-motor filter each time the dust bag is changed. Clean or replace as needed.

### To Clean Pre-Motor Filter

1. Remove filter centered in the bottom of the bag compartment.
2. Shake filter to remove excess dust. If necessary, the filter can be cleaned by vacuuming with another cleaner or washing with mild detergent.
3. Reinstall filter after completely dry.

Use GENUINE EUREKA replacement pre-motor filter, Part No. 71480.

### Models equipped with Cartridge Filter

(Only cartridge style filters can be used with these models.)

Check the True HEPA filter each time dust bag is changed. Replace twice a year or as needed.

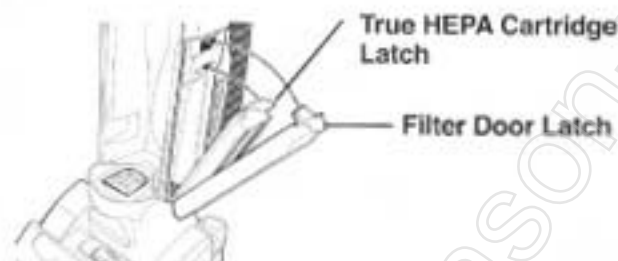

### To remove True HEPA cartridge filter

1. Push down on filter door latch and pull door away from cleaner.
2. Push down on HEPA cartridge latch and remove filter.

### To replace True HEPA cartridge filter

1. Place bottom tabs of filter cartridge into slots. Rotate filter toward cleaner, press firmly against cleaner to latch. **Make sure True HEPA cartridge latch is secured on both sides.**
2. Replace filter door by placing tabs of door into slots on cleaner. Rotate door up and against cleaner until it locks into place.

**NOTE:** To have the benefit of a sealed True HEPA system, you must use one of the True HEPA cartridge filter systems.

Use GENUINE EUREKA replacement True HEPA filter, HF5.

### How To Clean Filters

1. Remove from cleaner.
2. To remove debris, tap filter against waste container or brush off. You may also vacuum the filter using a different cleaner. If filter needs further cleaning, wash under warm running water.
3. **When all parts are completely dry,** follow the above steps in reverse to reassemble.

**NOTE:** Do not put any parts in a dishwasher.

**NOTE:** Your washable filter may need to be replaced if cleaning it does not restore cleaning performance.

Be sure to use GENUINE EUREKA replacement filters.

## PERIODIC MAINTENANCE

### How To Change Light Bulb (Only for models with a headlight)

**NOTE:** Turn off the power switch and disconnect the electrical cord before changing light bulb.

1. Lower handle. Remove the screw from lens cover.
2. Pull lens cover from cleaner.
3. Pull old light bulb out of socket.
4. Push new light bulb into socket.
5. Replace lens cover.
6. Secure with screw.



Use GENUINE EUREKA replacement light bulb, Part No. 57940-2.

## PERIODIC MAINTENANCE (CONTINUED)

### Brush Roll

The brush roll turns as it sweeps and combs the carpet nap. Remove hair and threads from the brush roll so it continues brushing the carpet. To maintain the most efficient cleaning, the bristles must touch the carpet. To test the bristle length, hold a ruler against the underneath side of the cleaner. If the bristles no longer touch the ruler, replace the brush roll.

### Brush Roll Belt, Style U

The brush roll belt turns the brush roll to agitate, sweep, and comb the carpet nap. Check the belt regularly to be sure it is in good condition. Replace the belt if it stretches, cracks or loses tension. Cut away any hair or threads wound around the brush roll or the belt pulley because the buildup could cause the belt to rotate unevenly.

### How To Replace Brush Roll Belt

**NOTE:** Turn off the switch and unplug the electrical cord before replacing belt. Belt pulleys can become hot during normal use. To prevent injury, avoid touching the motor shaft when changing the belt.

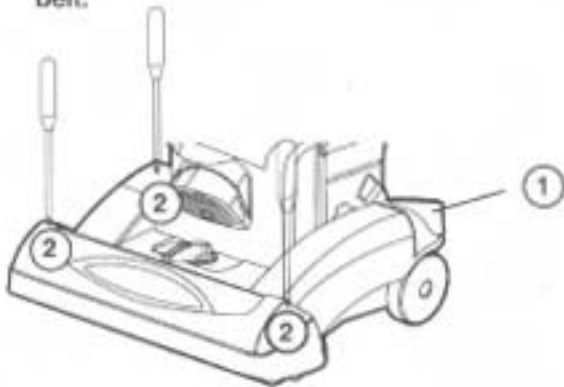

1. Lower handle to floor to change belt.
2. Remove three screws indicated by screwdrivers in above illustration. Lift hood to remove.

**NOTE:** The carpet height adjustment has to be in the lowest or highest position to remove or reinstall the hood.

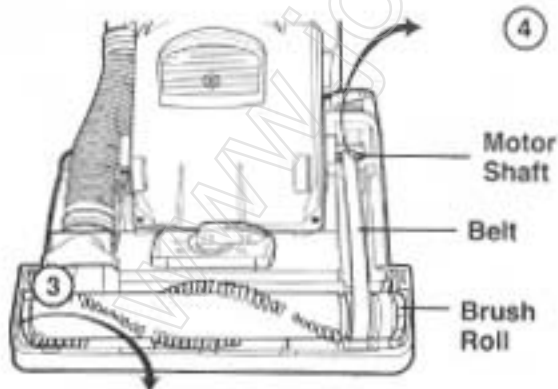

3. Lift left end of brush roll.
4. Remove and discard old brush roll.

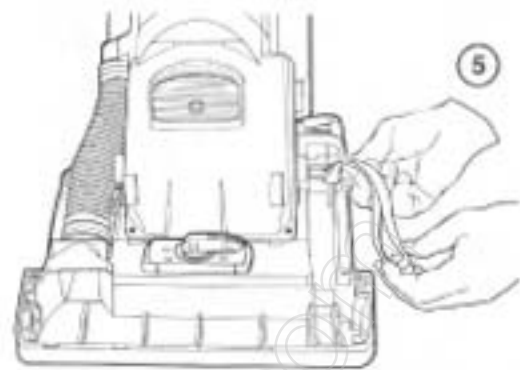

5. Place new brush roll around motor shaft.

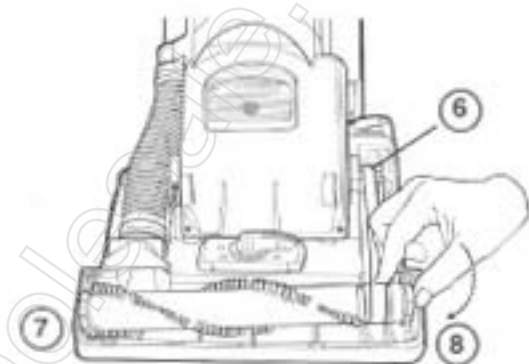

6. Place belt around brush roll pulley.
7. Align left end cap with base. Push end cap securely into place.
8. Push right end cap into base until it snaps into place.

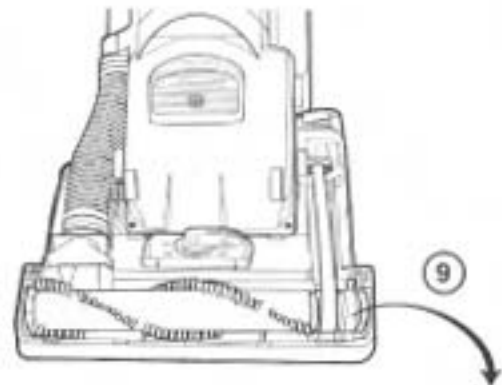

### IMPORTANT

9. Rotate brush roll by hand two full rotations to properly position belt.
10. Place hood back on cleaner. Make sure hood front is behind furniture guard. Replace three screws.
11. Tighten screws.

Use **GENUINE EUREKA** replacement belt, Style U. Look for the **GENUINE EUREKA** product symbol.

## Problem Solving

### To Clear Blockages in Hose

NOTE: Turn off the switch and unplug the electrical cord before clearing hose.

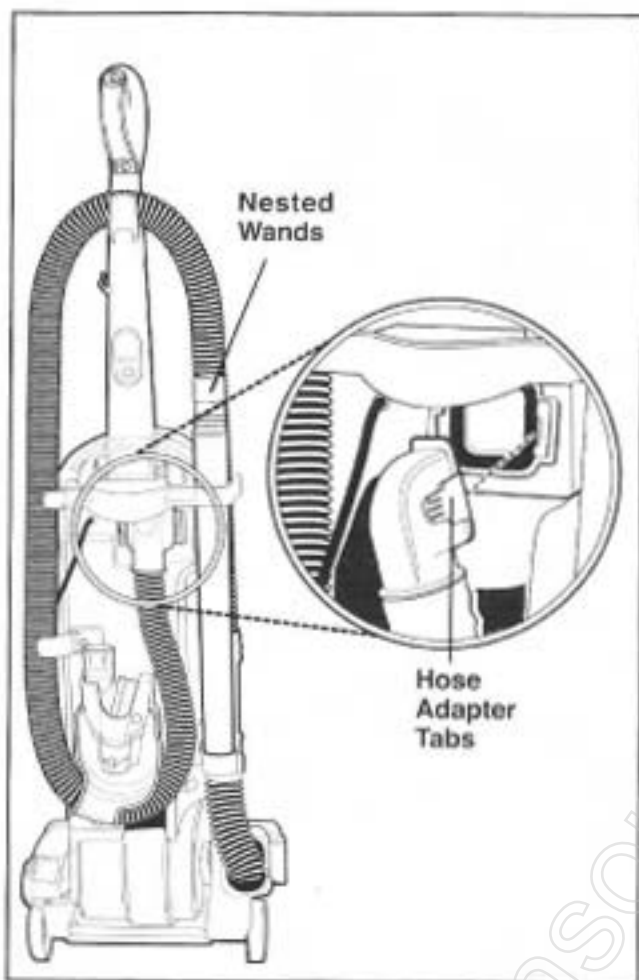

1. Locate upper hose adapter on the back of the cleaner.
2. Remove nested wands from back of cleaner for easy access to hose adapter tabs.
3. Press hose adapter tabs together and pull hose adapter away from cleaner. The hose adapter will unscrew off hose for easy access to debris if necessary.
4. Check for blockages at cleaner opening and in hose. If **no blockage is found, continue to step 5**. If blockage is found, clear and continue to step 11.

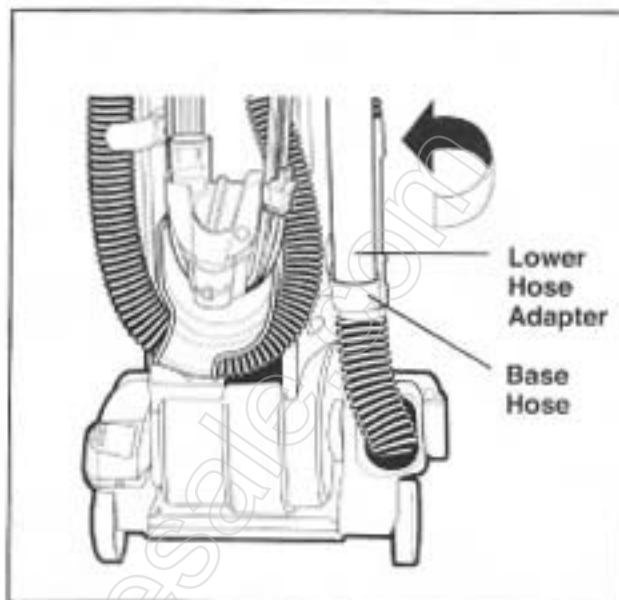

5. Locate lower hose adapter on the back of the cleaner.
6. Remove lower hose adapter from rear of cleaner by lifting up and twisting.
7. Check for blockages in the hose and base hose. Flexing the hose may help loosen any blockage. If no blockage is found, continue to step 8. If blockage is found, clear and continue to step 11.

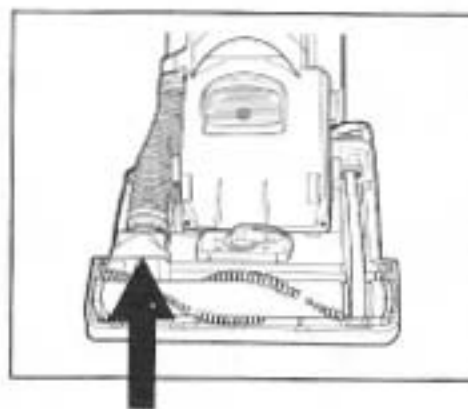

8. Remove hood from cleaner and check for a blockage in the brush roll area. Make sure the hose inlet is clear.
9. After the blockage is found and cleared, replace the hood on the cleaner.
10. Place lower hose adapter back into the base hose.
11. Install the upper hose adapter onto the back of the cleaner, line it up with the cleaner opening and push it against the cleaner until **both** tabs lock into place.

**NOTE: Turn off the switch and unplug the electrical cord before servicing.**

<b>PROBLEM</b>	<b>SOLUTION</b>
Motor will not start.	Push plug securely into outlet. Try another outlet. Check circuit breaker.
Motor suddenly stops.	Thermal Cut Off, see Page 2.
Does not clean the carpet or floor.	Clean or replace the filters. <b>Hint:</b> If picking up fine dust, the filters may not look dirty, but a fine substance tends to reduce suction when it blocks the airflow through the filters.  Be sure the dust bag is properly seated into the cleaner body. Page 8.  Replace dust bag. Page 8.  Be sure hose adapter is secure on back of cleaner. Page 11.  Check base hose and long hose. Page 11.  Replace a broken, cut, loose or out of shape belt.  Clean hair and thread from bristles and end cap area.  Replace brush roll if bristles are worn.
No suction at the end of hose.	Be sure hose adapter is secure. Page 11.  Clean or replace filters. <b>Hint:</b> If picking up fine dust, the filters may not look dirty, but a fine substance tends to reduce suction when it blocks the airflow through the filters.  Remove any clogs from the hose that restrict the airflow. Check base hose and long hose. Page 11.  Replace dust bag. Page 8
Headlight not working.	Replace light bulb. Page 9.
Noise from brush roll area.	Remove hood and clean debris or items from the brush roll area.  Replace a broken, cut, loose or out of shape belt. Page 10.
Cleaner is hard to push.	Put handle in operating position. Tilt the cleaner back to raise the front wheels off floor. Then turn the knob to a higher setting.  Replace a broken, cut loose or out of shape belt. Page 10.
Cleaner height knob will not turn.	<b>Hint:</b> Put handle in operating position. Tilt the cleaner back to raise the front wheels off floor. Then turn the knob.
Bag Cover will not go onto cleaner properly.	Dust bag must be installed properly in cleaner or bag cover will not go onto cleaner. Make sure the dust bag cardboard flange is on the support shelf. See page 8.
Hood will not come off.	Hood cannot be removed from cleaner unless the cleaner height setting is in the lowest or highest position.  All three screws must be removed from the top of the hood. Page 10.
Missing parts or questions?	Call 1-800-880-2913 between 8 a.m. to 7:30 p.m. (CST), Monday through Friday. Know the model and serial numbers when you call.