

## CAUTION

As with any electrical device, certain precautions for safe and efficient use apply. Please follow these simple rules and recommendations whenever using the Restorator:

1. Do not alter the plug or change the electrical wiring of the unit.
2. Always unplug the unit prior to installing or removing the odor neutralizer cartridge.
3. Do not use near or around water.
4. Always use in plain view, to assure proper operation.
5. If the unit ever appears to malfunction, unplug it immediately and contact your dealer or Vaportek for service advice.
6. The membrane cartridge is sealed. Do not puncture or open the internal membrane.
7. For best results, store cartridge in cool, dry place and replace after 270 hours of use.
8. To extend cartridge life, re-cap when not in use.
9. Keep Restorator cartridges away from extreme heat and from any sources of ignition.

### Five-Year Limited Warranty

Vaportek warrants this unit to be free from defects in workmanship or materials under normal use and service, for a period of five years from the date of purchase by the original purchaser. If at any time during the warranty period the product is found to be defective or malfunctions, Vaportek will repair or replace the defective part (at its option) and provide the shop labor to repair the product. This warranty shall not apply if it is shown by Vaportek that the defect or malfunction was caused by neglect or abuse by the consumer. This warranty does not cover any other charges incurred by the consumer. The sole responsibility of Vaportek shall be to repair or replace product within the terms stated above.

Vaportek shall not be liable for any consequential damages resulting from any breach of warranty, express or implied, applicable to this product. Some states do not allow the exclusion or limitation of consequential damages, so this limitation may not apply to you.

This warranty is in lieu of all other warranties, expressed or implied, and the warranties of merchantability and fitness for a particular purpose are hereby excluded beyond the five-year duration of this warranty. Some states do not allow limitation on how long an implied warranty lasts, so the above limitation may not apply to you. This warranty gives you specific legal rights, and you may also have other rights which can vary from state to state. This warranty applies only to products sold and used in the United States and Canada. Goods submitted for repair under this warranty must be sent, freight prepaid, to Vaportek, Inc.

**VAPORTEK** 

W226 N6339 Village Drive  
Sussex, WI 53089

800-237-6367 • www.vaportek.com • info@vaportek.com

**RESTORATOR**  
BY VAPORTEK

## Odor Neutralizing System

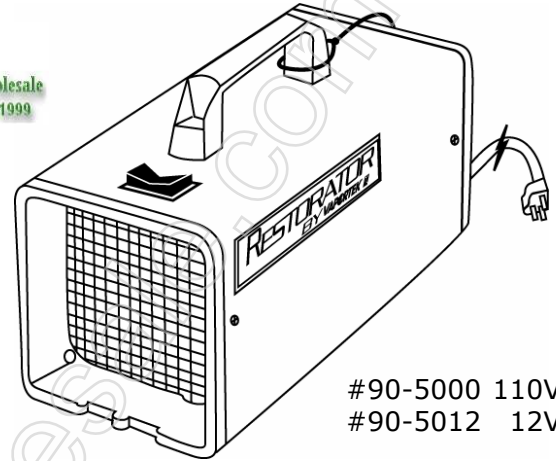

#90-5000 110V  
#90-5012 12V

## USE AND OPERATING INSTRUCTIONS

- **Simple to Use** — Just uncap the cartridge, insert in machine and turn on!
- **Works Fast** — Odor neutralizer delivery is immediate and permanent!
- **Safe & Environmentally Preferable** — No chemicals or harmful ozone!



# THANK YOU!

Thank you for purchasing the Restorator by Vaportek. This innovative appliance restores areas up to 20,000 cubic feet from odor contamination quickly, safely and economically.

With proper care, your Restorator will provide years of trouble-free service. Please read this short manual carefully before operating your Restorator, and keep it for future reference.



## SOME SUGGESTED USES

**CONTAMINATED HOTEL ROOMS** — Place the Restorator relatively high in the treatment area (i.e., on a table/off the floor). Let run 15-30 minutes to penetrate all porous surfaces.

**FIRE/SMOKE DAMAGE** — Close air vents and doors in room. Let Restorator run overnight or longer, depending on severity of damage. Residual deodorizer vapor will dissipate in a few hours after treatment and imbedded malodors will be eliminated.

**AUTO/BOAT RESTORATION** — The Restorator is ideal for removing cigarette, food, mustiness and other biological odors in cars, recreational vehicles, boats, etc. Run in closed treatment area for 15-30 minutes (light malodor problem) to 2-3 hours or more (for severe odor problems).

**ALSO IDEAL FOR REAL ESTATE, CLEANING AND CRIME SCENE SERVICES; FACILITIES MAINTENANCE; MORTUARIES; MEETING ROOMS; AUTO RENTAL AGENCIES; USED CAR DEALERS, DETAIL SHOPS...AND COUNTLESS OTHER APPLICATIONS WHERE PROBLEM ODORS EXIST!**

# INSTRUCTIONS

The Restorator is a simple-to-use, portable electric system that quickly, safely and effectively neutralizes odors in interior spaces up to 20,000 cubic feet.

As this unit does not have any "fine" output control, it is primarily intended for fast odor-neutralizing treatment at high intensity. The characteristic neutralizer fragrance, therefore, will be very noticeable in operation, as the essential oils circulate throughout the treatment area at full output from the machine.

For initial treatment, it is suggested that the #90-5150 (3X Industrial) or #90-5150-85 (S.O.S./Smoke Odor Solution) cartridge be used. The High-Output (#90-4120) cartridge may also be used and is available in several fragrances for follow-up treatment, if desired.

Place the unit where air flow at both ends is unblocked, preferably in a relatively high location. Locate on a hard, stable surface. Be sure the replaceable cartridge is properly installed (see instructions below), with the plastic cap removed from the cartridge prior to installation. To preserve cartridge life, always store with the cap on when not in use.

Turn the unit on and allow it to deliver odor-neutralizing dry vapor for a few minutes. In many cases, deodorization will be complete in 30-60 minutes. For more severe contamination, treatment may take several hours or even days.

Dry vapor output will be affected by humidity and temperature, with vapor release significantly reduced in excess humidity conditions (90-100%). Normal interior conditions allow the unit to work well. Ideal temperature range for best dry vapor release is 60°-110° F.

Finished surfaces may be damaged by direct contact with cartridge oils. The essential oils used in the membrane are non-toxic; however, if the oils should leak, wash affected skin, clothes or surfaces with soapy water.

The Restorator is designed for use only with Vaportek-approved replacement cartridges. Use of non-approved replacement cartridges will void warranty coverage and may cause risk of injury. For best results, replace cartridge after 270 hours of use.

Fig. 1

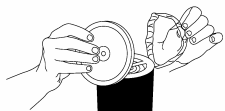

Lift off lid and discard clear film liner. (Slight wetness under cap is normal.)

Fig. 2

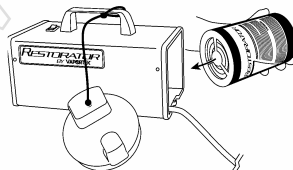

Place cartridge into back of machine with open end of cartridge inserted first. (If substantial oil leakage [dripping] is evident, do not use. Re-cap and contact dealer or Vaportek.)

Fig. 3

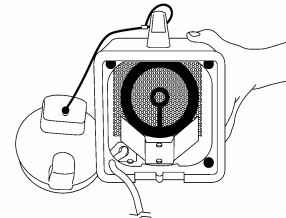

Be sure cartridge is positioned properly in the internal cradle, with open end resting against the black gasket.

Fig. 4

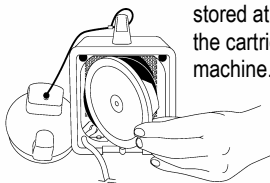

When machine is in use, the plastic lid can be stored at the back end of the cartridge inside the machine.

Fig. 5

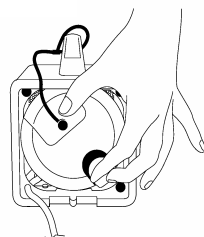

Replace spring-loaded rear cover plate by pressing it against the cartridge while turning, until it locks into place.

Fig. 6

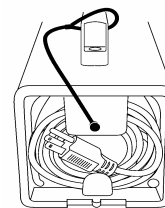

To operate, plug cord into appropriate power outlet. Always unplug Restorator before removing cartridge. To prolong cartridge life, remove from machine, re-cap and store cartridge upright in a cool, dry place. The Restorator cord can be coiled for storage in the back of the rear cover plate.